

1.1.1 Photodiode Power Sensors

1.1.1.1 Standard Photodiode Sensors

50pW to 3W

Features

- Very large dynamic range
- Swivel mount for hard to measure places
- Comes with filter in / filter out options
- Patented automatic background subtraction
- Fiber optic adapters available

PD300 with filter off



PD300 with filter installed



PD300-TP Mounted on stand



Model	PD300			PD300-1W			PD300-3W			PD300-TP		
Use	General			Powers to 1W			Powers to 3W			Thin profile for tight fit		
Detector Type	silicon			silicon			silicon			silicon		
Aperture	10x10mm			10x10mm			10x10mm			10x10mm		
Calibration Uncertainty nm	±1.1% 430-1000 ^(b)			±1.1% 430-1000 ^(b)			±1.1% 430-1000 ^(b)			±1.1% 430-1000 ^(b)		
Filter Mode	Filter out	Filter in		Filter out	Filter in		Filter out	Filter in		Filter out	Filter in	
Spectral Range nm	350-1100	430-1100		350-1100	430-1100		350-1100	430-1100		350-1100	400-1100	
Power Range	500pW to 30mW	2μW to 300mW		500pW to 30mW	2μW to 1W		5nW to 100mW	2μW to 3W		50pW to 3mW	2μW to 1W	
Power Scales	30mW to 30nW and dBm	300mW to 300μW and dBm		30mW to 30nW and dBm	1W to 300μW and dBm		100mW to 300nW and dBm	3W to 300μW and dBm		3mW to 3nW and dBm	1W to 300μW and dBm	
Resolution nW	0.01	NA		0.01	NA		0.1	NA		0.001	1	
Maximum Power vs. Wavelength	nm	mW	mW	nm	mW	mW	nm	mW	mW	nm	mW	mW
	<488	30	300	<488	30	1000	<488	100	3000	350-400	3	NA
	633	20	300	633	20	1000	633	100	3000	400-500	3	1000
	670	13	200	670	13	1000	670	100	2000	600	2.5	1000
	790	10	100	790	10	600	790	100	1200	700	2	500
	904	10	100	904	10	700	904	100	1200	800-950	1.5	300
	1064	25	250	1064	25	1000	1064	100	2200	1064	3	500
Accuracy (including errors due to temp. variations)												
% error vs Wavelength nm	±10	360-400	NA	±10	360-400	NA	±10	360-400	NA	±7	350-400	NA
	±3	400-980	±5	430-980	±3	400-950	±5	430-950	±3	400-950	±5	400-450
	±5	980-1100	±7	980-1100	±4	950-1030	±6	950-1030	±4	950-1030	±6	450-950
					±6	1030-1100	±7	1030-1100	±6	1030-1100	±7	950-1100
Damage Threshold W/cm ²	10	50		10	10 ^(a)		10	30		10	50	
Max Pulse Energy μJ	3	30		3	200		30	400		1	100	
Noise Level for filter out pW	20			20			200			±2		
Response Time with Meter s	0.2			0.2			0.2			0.2		
Beam Position Dependence	±2%			±2%			±2%	±3%		±2%		
Background Subtraction	95-98% of background is cancelled automatically under normal room conditions, even when changing continuously						N.A.			N.A.		
Fiber Adapters Available (see page 32)	ST, FC, SMA, SC			ST, FC, SMA, SC			ST, FC, SMA, SC			N.A.		
Compliance	CE, UKCA, China RoHS			CE, UKCA, China RoHS			CE, UKCA, China RoHS			CE, UKCA, China RoHS		
Version							V1					
Part Number	7Z02410			7Z02411A			7Z02426			7Z02424		

Notes: (a) Maximum power density above which sensor may not read correctly. There will be no permanent damage until 50W/cm²
 (b) For calibration uncertainty of wavelengths outside of this range see table on page 24

* For graphs see page 30-31

* For PD300-3W drawing see PD300-UV/PD300-IR drawing on page 26

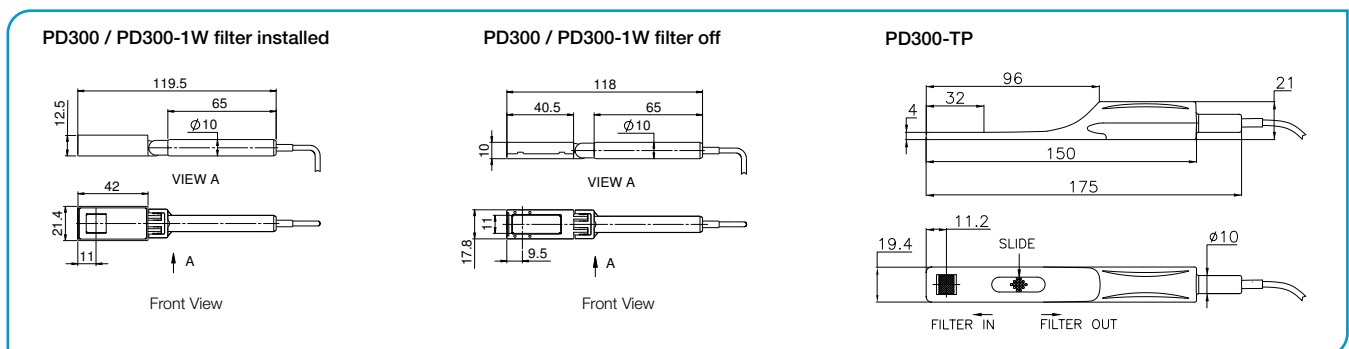

Temperature Coefficient of Sensitivity

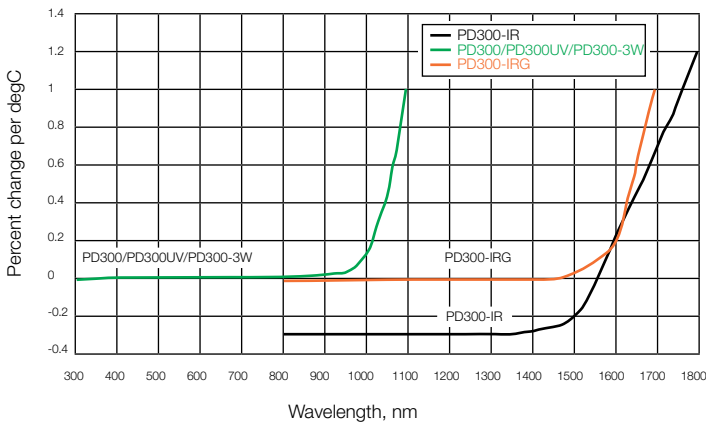

PD300 Angle Dependence

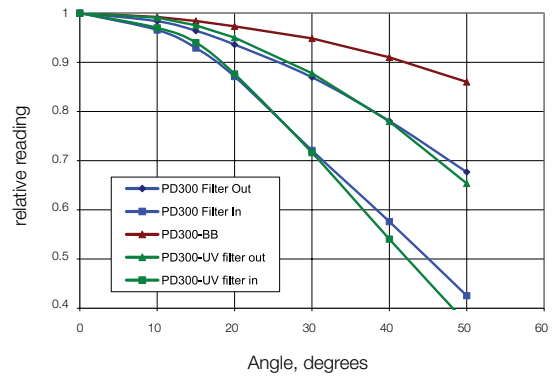

Dependence of Sensitivity on Numerical Aperture (PD300 - IRG)

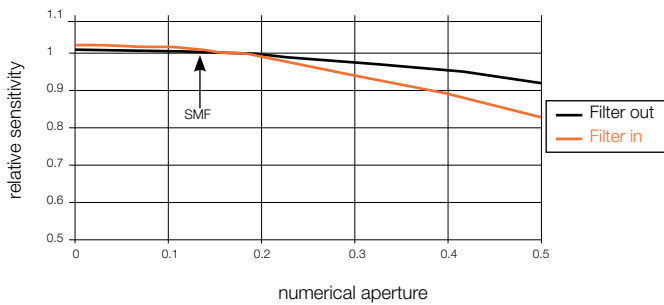

Note:
 1. Graph assumes equal intensity into all angles up to maximum N.A.
 2. Calibration is done with SMF, N.A. 0.13

PD300-CIE Spectral Response vs. CIE Curve

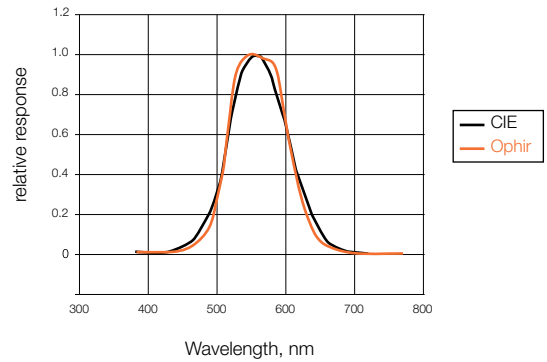

Typical Sensitivity Curve of PD300-BB Sensors

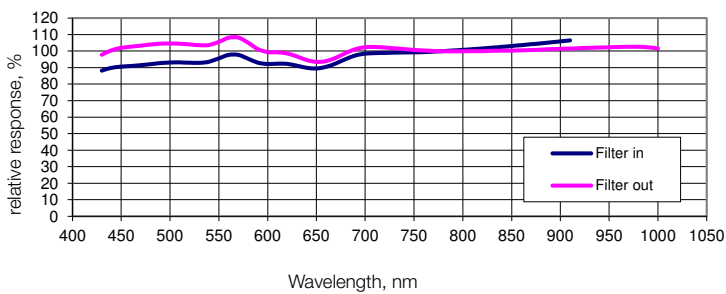

BC20 Relative Spectral Response

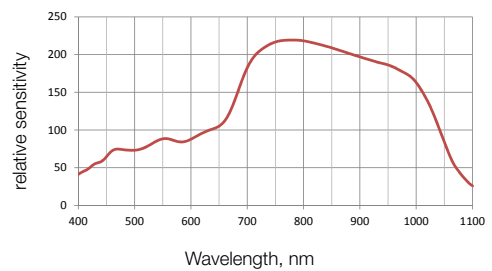

Approximate Spectral Response

Relative to 633nm or 1550nm

